

# IWALK: THE EASIER WAY





# ENHANCING URBAN MOBILITY: WITH ESCALATORS SINCE 1906

One World Trade Center's flying escalator, USA

January 2018 marked the 125th anniversary of the first-ever escalator. It was more or less invented by accident. Jesse Reno had been trying to create New York's first double-decker subway but ended up with a moving stairway traveling at a 25° angle for a mere seven feet (2.13 m). But in just two weeks it carried some 75,000 passengers at the Old Iron Pier on Coney Island. A global success story was born.

## **In escalators since 1906**

We were soon into the escalator business with our first model installed at a department store as long ago as 1906. 115 years of engineering excellence go into our velino 100, 200 and 300 models.

## **As diverse as they come**

We build mobile escalators for boarding and disembarking aircraft, restaurant escalators with just one moving handrail for waiters with only one hand free, and suspended escalators that crisscross the open space of an atrium. You name it, we build it.

## **Remarkable locations**

Our underwater installation at Shanghai's Ocean Aquarium ensures visitors enjoy spectacular sights.

The One World Trade Center in New York has 12 of our escalators and 71 elevators. We also equipped the world's largest department store in Busan. Higher, bigger, better – escalators from TK Elevator.

## **Myth debunked**

“Stand on the right, walk on the left” actually slows down passenger flow. Studies show that escalator capacity increases by about 30% if nobody walks. At TK Elevator, we know the escalator business like the back of our hand and it's this expertise that makes our new velino series so special.

# CONTENTS

04

The iwalk at a glance

06

A design to enhance any surroundings

08

True quality is evident in ease of handling

10

Design details to improve safety

12

Moving forward – sustainability in practice

14

iwalk around the world

16

Service

18

Design tools

19

About us



Base parameters iwalk:

Lenght	100 m
Inclinations	0°-6°
Step width	1,100   1,400 mm
Speed	0.5   0.65 m/s
Environment	Indoor   Outdoor

Designed for:

- Airports
- Metro-Links
- Retail
- Museums
- Convention Centers

Zurich Airport, Switzerland



# THE MOVING WALK REINVENTED FOR EASE OF USE



Moving walks have existed since 1893. We thought it was time this integral component of urban mobility at airports, shopping centers, metro stations and the like was in need of a reinvention. There are enough good reasons. For example, the sheer size of most moving walks requires extensive construction work for their installation. In some cases it is not even possible.



## Designed for ease of use

iwalk, a new industry benchmark, is a cutting-edge solution to the challenge of transporting people, trolleys and the like. Increased interior space, minimal comb heights and reduced outer dimensions combine for convenient ease of use.



## Project-friendly integration

Easier planning and suitable for sensitive surroundings, including outdoor locations. The reduced weight, lower static load requirements and modular structure allow for design flexibility, while the pitless solution eliminates the need for additional civil work.



## Outstanding benefits

Maximum efficiency and reliability with proven state-of-the-art technology, easy installation and excellent service ensures profitability. And with minimal transport packaging, your project will also benefit from a lower carbon footprint.

# A design to enhance any surroundings



## Distinctive balustrade design

iwalk features a slimline balustrade that can be equipped with a specially designed light channel. The balustrade decking profile can be used for attractive LED lighting. This distinctive design is a standout feature in any surroundings.

## Easier on the eye

The new design also does away with the need for visible screws along the entire unit. This aspect gives iwalk a streamlined, state-of-the-art look. What's more, the higher proportion of glass in the glass-steel construction will also enhance your building's visual appeal.



Whatever technical qualities a moving walk may have, what it looks like is of prime importance. After all, it's an eye-catcher in any building, and first impressions count. So we've made sure that iwalk will add to the visual appeal of your building. As an industry first, product design specialists helped us in designing this moving walk, and the outcome is a design that fits in superbly well with any modern-day architecture.



### Attractive lighting options

Lighting is an eye-catching design feature. That's why iwalk offers a wide variety of lighting options such as the under-handrail lighting that lets the handrail float over the balustrade to put your project in the right light. Just choose the lighting that best suits your surroundings.

### Outer decking replacement

Even scratches will be no problem since the outer decking can be easily replaced with no trouble at all.

# True quality is evident in ease of handling

Quality begins with design. Right from the start of our plans to reinvent the moving walk, we integrated quality factors into design development. The outcome is a moving walk that is easier to plan and integrate into your building or outdoor location. iwalk simply makes it easier to meet all your needs.

## Easier integration

iwalk consists of standardized modules, which are delivered in handy packages. This not only allows speedy transportation, as with planes, but also eases their integration as well. iwalk can be the last unit to be incorporated after construction, i.e. you can store the modules and bring them to their final location, even by elevator.

## Easier on the building

iwalk's unique configurations as semi-pit or pitless versions reduce the need for civil works or even eliminate them since you can simply place iwalk on the finished floor. In combination with 30% weight reduction compared to conventional designs, this gives you the chance to reduce, for example, floor thickness and thus enhance the visual quality of your building through higher ceilings.

## Easier planning

iwalk's modules are easily interchangeable or replaceable so that even last-minute design changes are possible. If you decide you need to relocate your unit, iwalk makes it an easier option. All you need is a forklift truck. And the best thing is that if your building is not yet equipped with a conveyor system, iwalk allows infrastructural upgrades without additional civil works.

## Easier to meet your needs

iwalk has been designed to meet the needs of its operator and all its users. In compliance with international codes, iwalk's standard 1,100 mm pallet width enables large trolleys and shopping carts to be used with ease. So you won't need to upgrade to a wider, more expensive pallet band, and your users will enjoy maximum convenience and safety. Additional access ramps are available for the pitless version.

30%

LESS WEIGHT

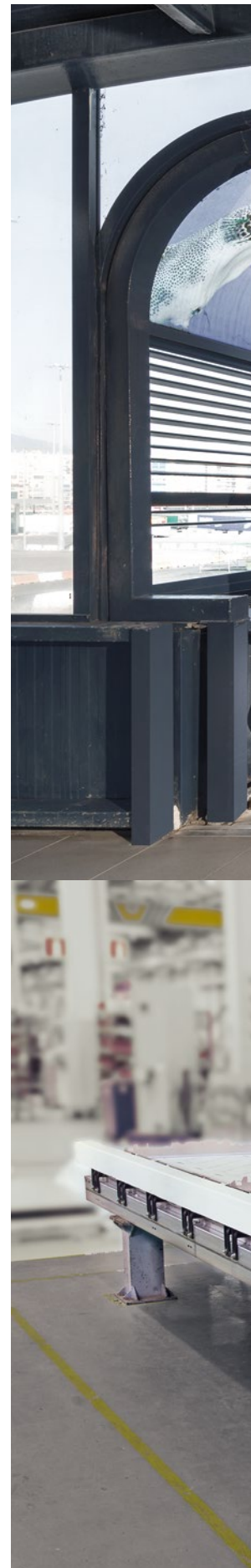





# Design details to improve safety

Compliance with safety codes is critical in today's safety-conscious world. This moving walk fulfills the safety requirements of all the relevant codes. With more than 50 safety features – standard, optional and beyond – iwalk has been designed so that the user can use this moving walk more safely.



## Full handrail guidance

With an extended guidance handrail at the entrance and exit iwalk supports users in entering and leaving, which is especially helpful for the elderly and disabled.

## Useful traffic lights

Several traffic light options help to guide traffic and clearly show an approaching user if an iwalk is functional and running in the desired direction.



**12mm**  
Safety glass

Extended balustrade

**7mm**  
Comb height  
80% less

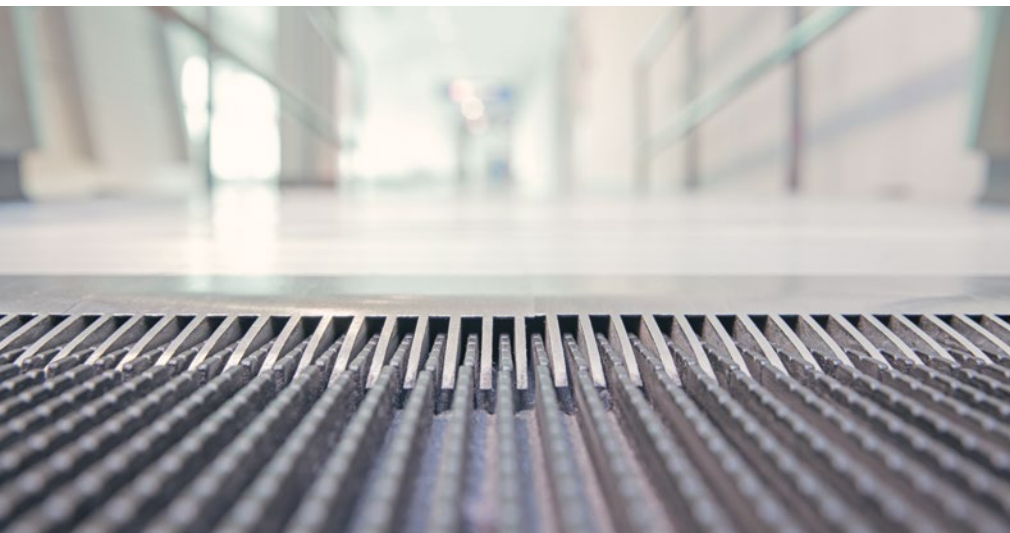

### Flatter combs

The comb segments of iwalk are only 7mm above the pallet band, a reduction of around 80% compared to conventional designs. These almost flat combs greatly reduce stumbling risk in particular for persons of reduced mobility or trolley users.

### Handrail inlet

The unique TKE handrail inlet with a two door flap system eliminates rubber guards or brushes and reduces unintended activation. The wide opening is a safety improvement.

# Moving forward – sustainability in practice

Since iwalk moves people forward, it is a matter of principle for us that this “forward-mover” be constructed in a forward-thinking way. So sustainability is a key design factor and constructional feature of iwalk. We not only manufacture it in a resource-efficient way, we have reduced the number of components and its weight, and offer energy-saving features that give it a lower overall energy consumption than conventional moving walks.

## Welcome savings for you and the environment

Thanks to its reduced weight and intelligent energy efficiency measures, such as the smart frequency converter, iwalk achieves A+++ ratings in accordance with ISO25745-3, the global standard for escalator and moving walk classification. This helps in having your building certified.

## Easier transportation

A modular design and lighter construction facilitate transportation so fewer trucks or containers are required than with a conventional design. This reduces the CO2 footprint during transportation.

## Easier on resources

The materials and components used in a moving walk impact on the environment. iwalk’s new design concept, in contrast, features a streamlined material mix that reduces the environmental impact during operation by up to 20%.

## Easier operability

The innovative pallet construction and power transmission system need no chains and thus no lubrication either. As a result, iwalk eases the maintenance workload and reduces the impact on the environment, while at the same time offering users a safe ride.

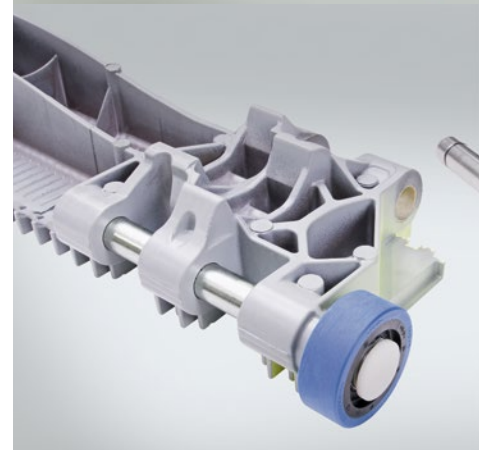
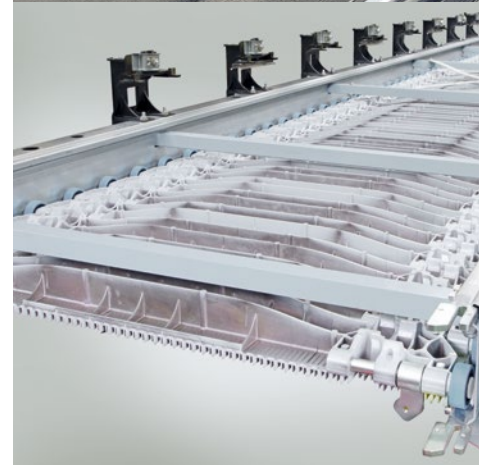
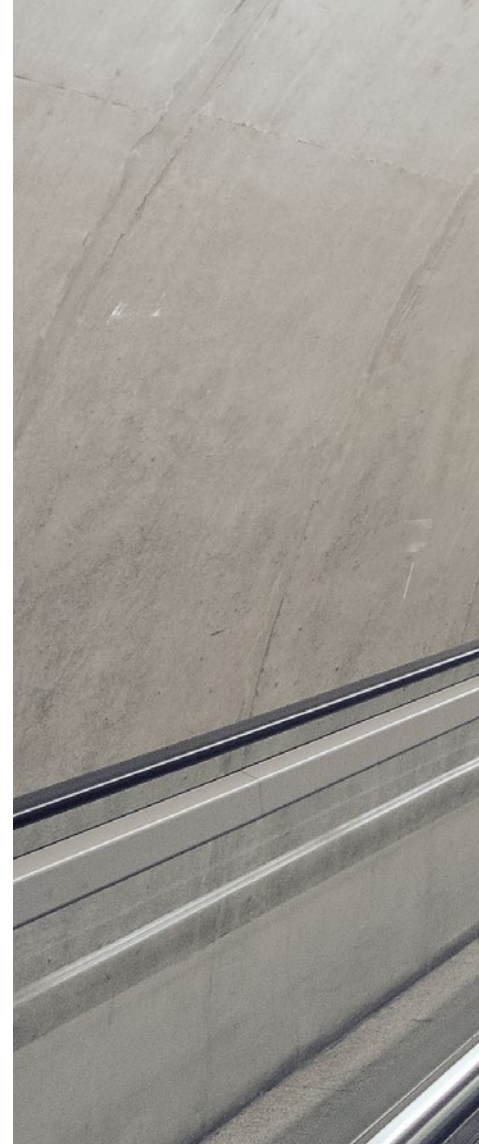

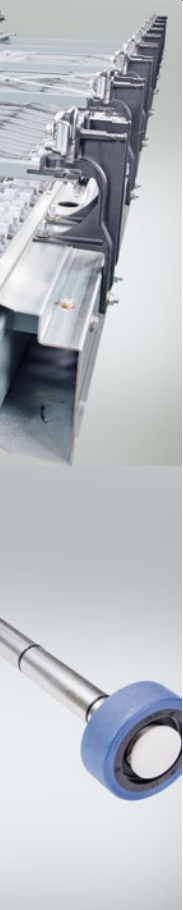

#### Energy-efficient lighting

State-of-the-art LED technology lasts longer than conventional lighting and is up to 80% more energy-efficient than halogen lighting.

#### Energy-saving operations

Depending on your load cases, operational modes such as standby or sleep mode and the regenerative drive option can help make your moving walk more energy-efficient.

#### Lower environmental impact

By continuously improving our moving walk solutions, we minimize their environmental impact in product lifecycle assessments.

## Energy efficiency

**A+++**

**ISO 25745-3**

#### Continuous operation

SAVE UP TO

**15%\*** 

#### Intermittent operation

SAVE UP TO

**95%** 

#### Slow speed operation

SAVE UP TO

**60%** 

#### Slow speed stop operation

SAVE UP TO

**90%** 

\* Only applicable with Star-Delta

# iwalk around the world

iwalk is the the globally preferred solution for high-class applications.



Calgary Airport ■

JFK International ■

Heathrow Airport ■

Lissabon Airport ■ ■

Hia Airport ■

— ■  
Metro Sao Paulo  
Evolution Corporate  
Brasilia Airport  
Guarulhos Airport  
Fortaleza  
Metro Rio de Janeiro

— ■  
Metro Madrid  
Atocha Train Station  
Malaga Airport  
Ayto de Portugalete  
Puerto de Algeciras  
Cuba en Badalona  
Metro Bilbao  
Barajas Airport



■ Arlanda Airport

■ Copenhagen Airport

■ Altenessen Fraport

■ C&C Amort Lana Malpensa Airport

Izmir Aiport

Trump Tower

Akasya

Zorlu Center

Metro Istanbul

■ Metro Zhulebino

■ New Doha Airport

Binsulaiman Center

Madinah Airport

Hilton Hotel Riyadh

■ Bangalore Airport

■ Kuala Lumpur Airport

■ Bali Airport

Perth Airport ■

Melbourne Airport ■

# YOUR SERVICE PARTNER: ALWAYS THERE



Whatever your commercial operation, you need a moving walk that is installed on schedule and, once running, ensures people can get where they want to go quickly and effortlessly. Our installation expertise will make sure your iwalk starts operating on time. Our technical and service support will keep it running smoothly from then on.



More details about MAX are available via this QR code.

## MAX – the game changer that keeps people moving

Introducing MAX: the elevator industry's first real-time, cloud-based predictive maintenance solution. Our smart, machine learning Internet of Things (IoT) solution dramatically increases elevator availability by reducing out-of-service situations through real-time diagnostics.



Data gathering



Precise diagnostics



Predictive intervention

MAX is only available in selected markets. Consult your TK Elevator sales representative for further information.



## Ensuring continuous people flow

### On-schedule installation

Our expertise in planning and project management, the vigorous process we employ to select suitable installation teams, and the regular training all our personnel go through are the reasons why we can deliver installation on time – anywhere in the world and in any kind of commercial building.

### Maximising equipment uptime

Our service goal is quite simple: maximise your moving walk uptime. When you need support, our highly trained service technicians will be quickly on hand with the right spare parts and know-how to ensure your iwalk stays running smoothly or is back operating again in the shortest possible time.

### Tailor-made service packages

Choose from a variety of service and maintenance packages ranging from basic maintenance to EN 13015 through to comprehensive support. As our service technicians are all specialists in specific application areas, we work closely with you to understand your needs and come up with a customised service concept. That will not only enable you to meet your reliability and safety goals but also give you cost transparency and budget security.

## Interesting numbers

4,500,000,000

passengers per day

637,000

numbers of units worldwide

7,000

average number of passengers  
per unit per day

# Design tools: making your life easier

We supply you with a number of state-of-the-art tools so your architects, engineers and construction specialists can efficiently plan, design, construct and manage your building and infrastructure.



## eSlider: Easier preliminary planning

Our eSlider tool enables you to generate your moving walk specifications online. This will make your preliminary planning that much easier.



More details of the eSlider tool are available via this QR code.

## BIM: Building Information Modeling

BIM is an intelligent 3D model-based process that provides the insights and tools for a seamless information flow from design to execution. At TK Elevator we work with the world's leading BIM content platform, BIMobject®, where you can download our iwalk BIM.



More details of the BIM tool are available via this QR code.

# YOUR INNOVATION PARTNER

elevators and escalators under maintenance

countries of customers

1,200,000 100+

employees

50,000+

service available of customers

locations

24/7 1,000+

service technicians

24,000+



[www.tkelevator.com](http://www.tkelevator.com)